

TYANSHINE

Package Dimensions:

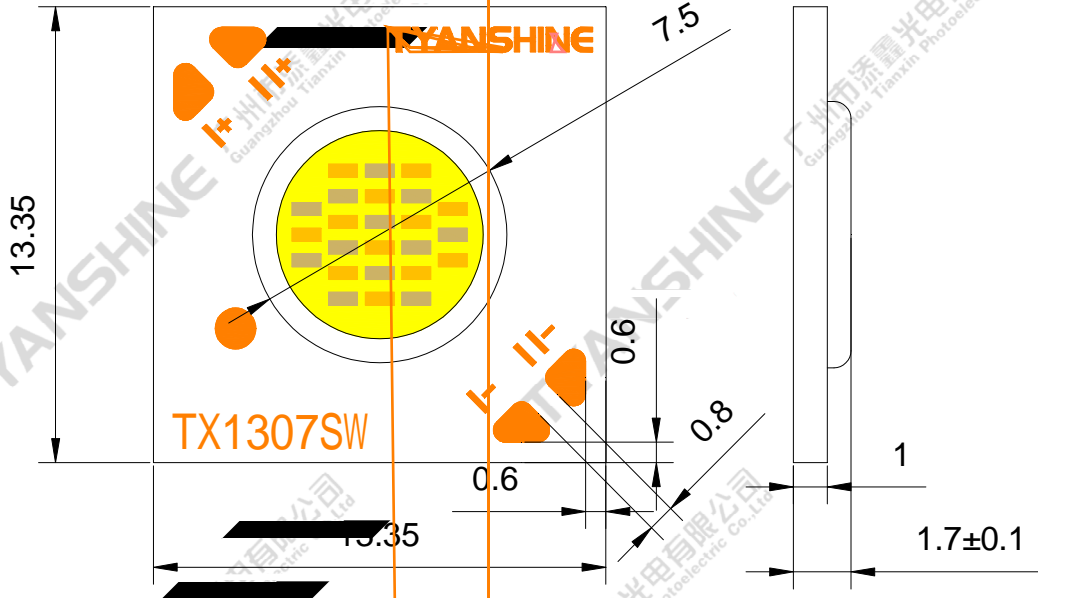

Part No.	TX-1307SW08A-2860V36-10H90	Spec No.	WKF-BF0372	Page	2 of 10
----------	----------------------------	----------	------------	------	---------

Absolute Maximum Ratings

Parameter	Symbol	
Forward Current	IF	
Reverse Voltage	VR	
Power Dissipation	PD	W
		S
Junction Temperature	Tj	W
		S
Case Temperature (C)	Tc	
Electrostatic Discharge Threshold (ESD)	ESD	
Storage Temperature	Tstg	
Operation Temperature	Topr	

Notes:

- 1.Specifications are subject to change without notice.
- 2.The data on this specification is for

Electrical Optical Characteristics (Tc=25°C)

Parameter	Symbol	Condition	Emitting color	Min.	Typ.	Max.	Units
Luminous Flux	v	If=200mA	S	—	600	—	lm
			W	—	750	—	
Forward Voltage	V _f		S	34	36	38	V
			W	34	36	38	
Correlated Colour Temperature	CCT		S	—	2800	—	K
			W	—	6000	—	
Viewing Angle at 50° IV	2 1/2		S	—	115	—	Deg
			W	—	115	—	
Reverse Current	I _r		—	—	—	—	μA
Thermal Resistance Junction to Case	R _{J-C}		S	—	2.07	—	K/W
		W	—	2.07	—		
Temperature Coefficient of Voltage	V _{F/T}	S	—	-17	—	mV/	
		W	—	-17	—		
Color Rendering Index	Ra	S	—	90	—	—	
		W	—	90	—		

Notes:

- 1.Luminous intensity is measured with a light sensor and filter combination that approximates the CIE eye-response curve.
2. 1/2 is the off-axis angle at which the luminous intensity is half the axial luminous intensity.
- 3.Luminous flux measurement tolerance:±15%.
- 4.Forward voltage measurement tolerance:±0.15V.

Part No.	TX-1307SW08A-2860V36-10H90	Spec No.	WKF-BF0372	Page	4 of 10
----------	----------------------------	----------	------------	------	---------

TYANSHINE

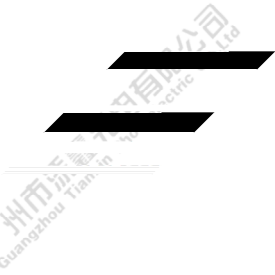

TYANSHINE 广州市天鑫光电有限公司
Guangzhou Tianxin Photoelectric Co., Ltd.

TYANSHINE 广州市天鑫光电有限公司
Guangzhou Tianxin Photoelectric Co., Ltd.

TYANSHINE 广州市天鑫光电有限公司
Guangzhou Tianxin Photoelectric Co., Ltd.

TYANSHINE 广州市天鑫光电有限公司
Guangzhou Tianxin Photoelectric Co., Ltd.

TYANSHINE 广州市天鑫光电有限公司
Guangzhou Tianxin Photoelectric Co., Ltd.

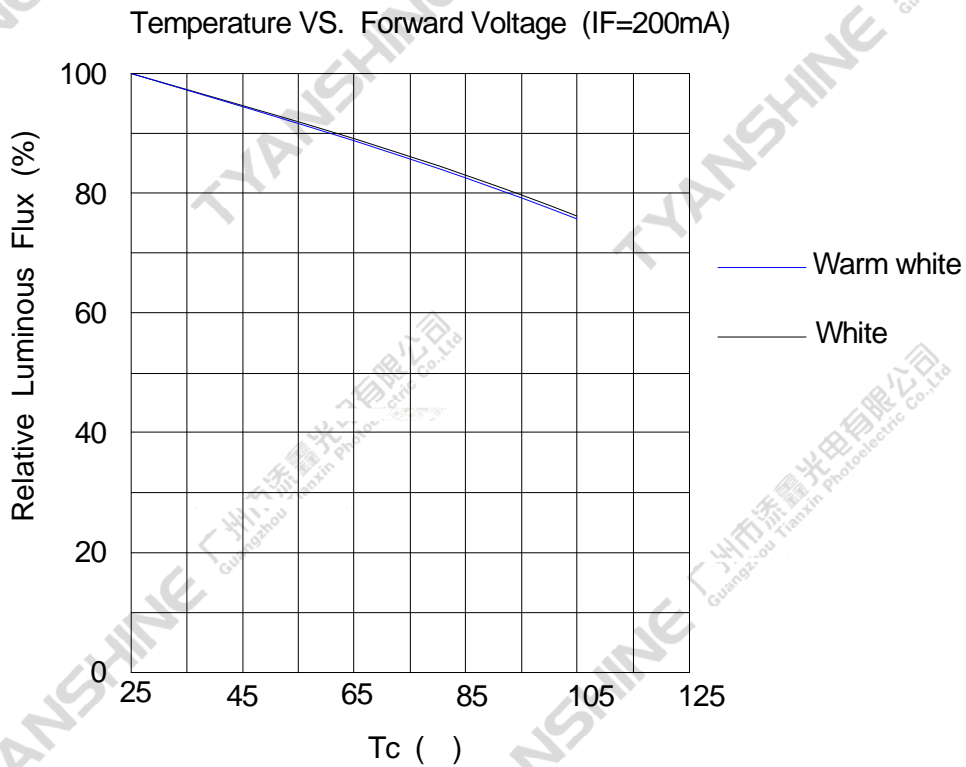
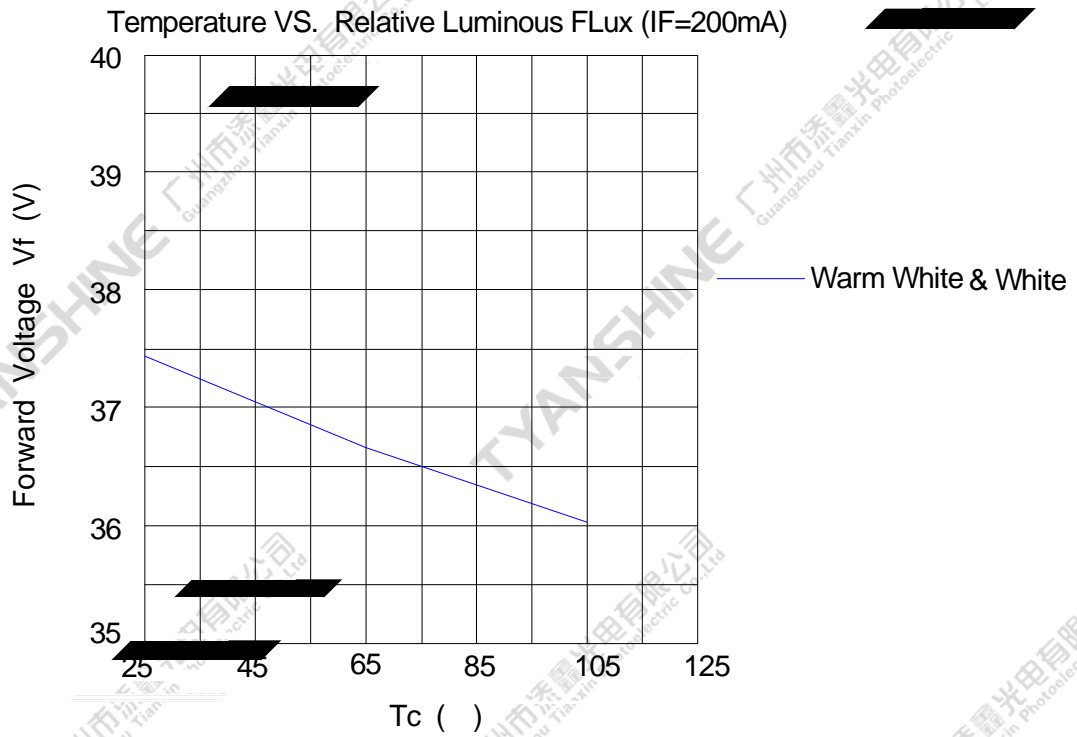

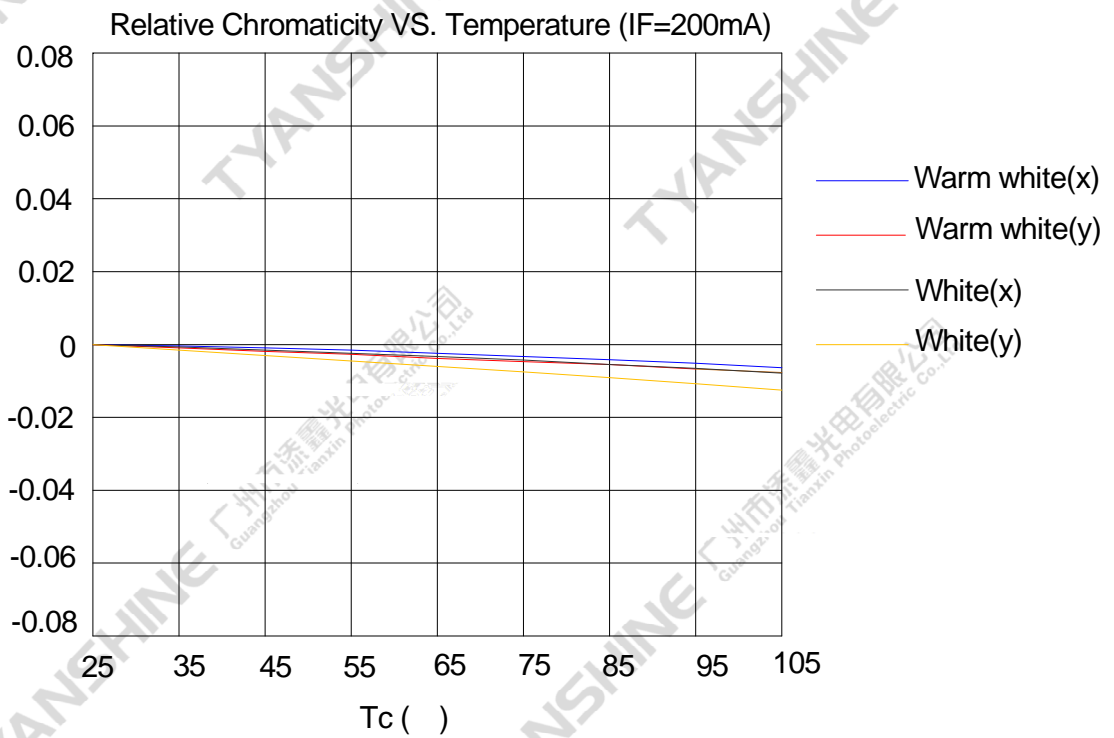
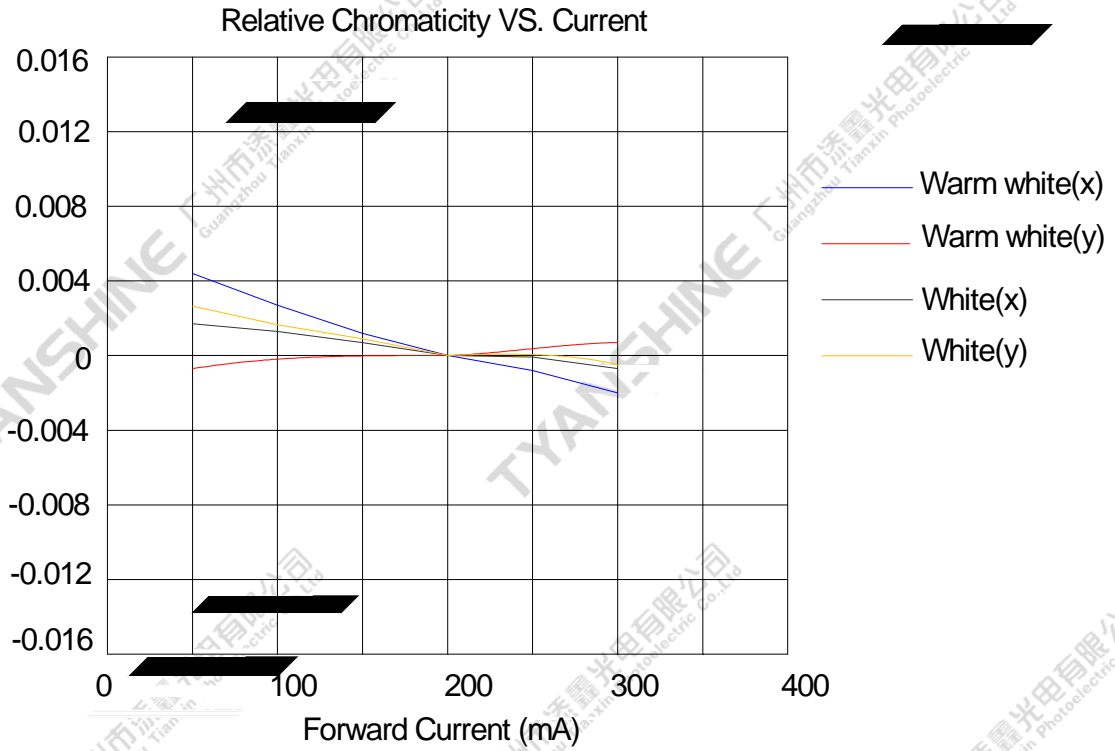

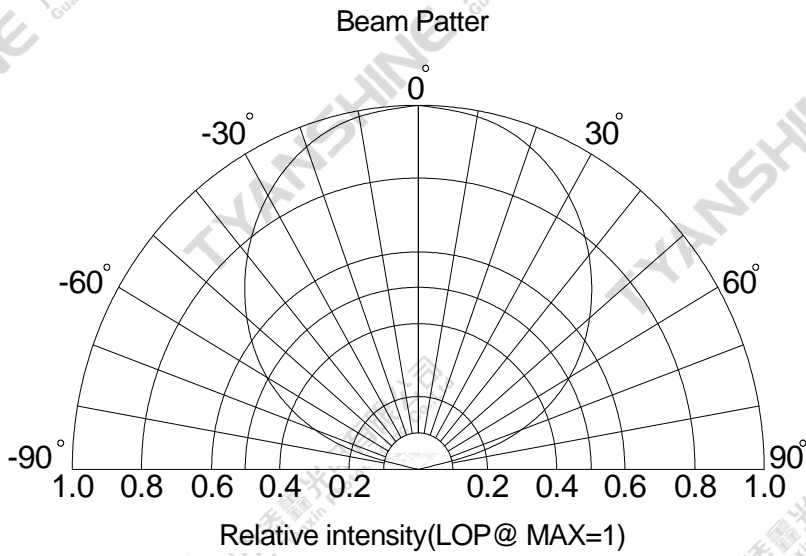
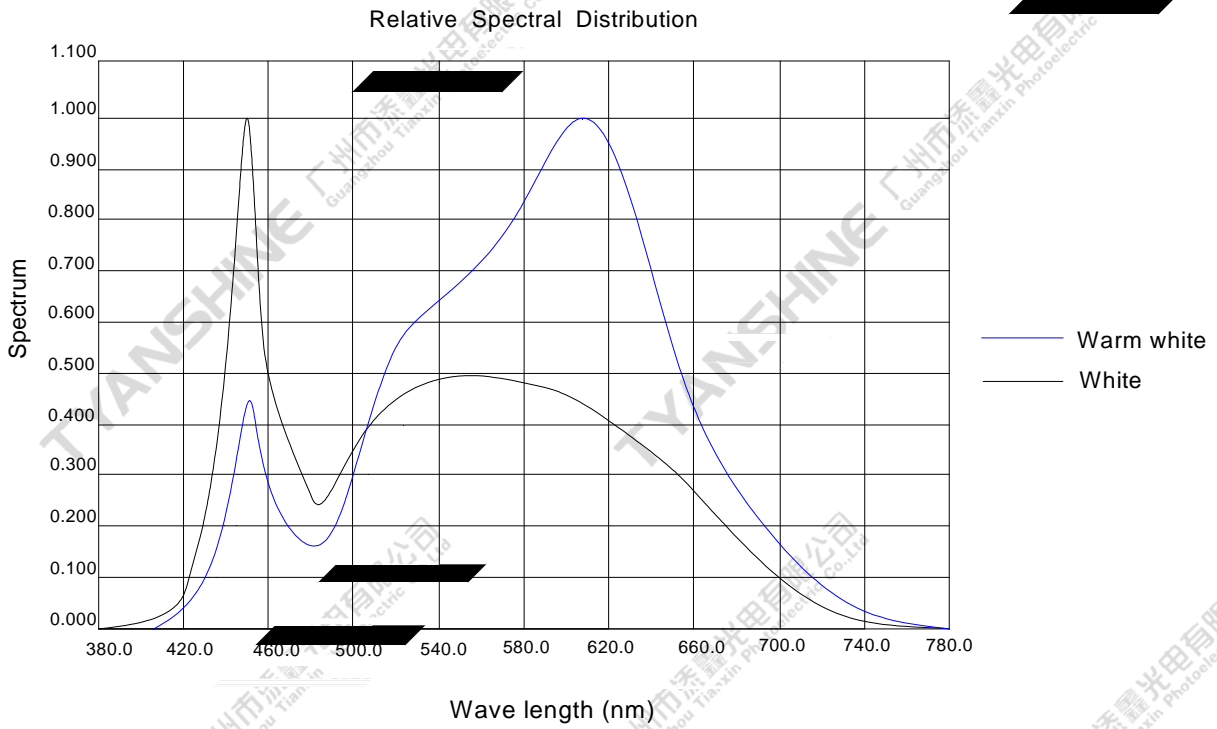

Notes:

1. 2 1/2 is the off axis angle from lamp centerline where the luminous intensity is 1/2 of the peak value.
2. View angle tolerance is $\pm 5^\circ$.

Part No.	TX-1307SW08A-2860V36-10H90	Spec No.	WKF-BF0372	Page	8 of 10
----------	----------------------------	----------	------------	------	---------

Chromaticity Coordinates Condition IF=200mA Tc=25

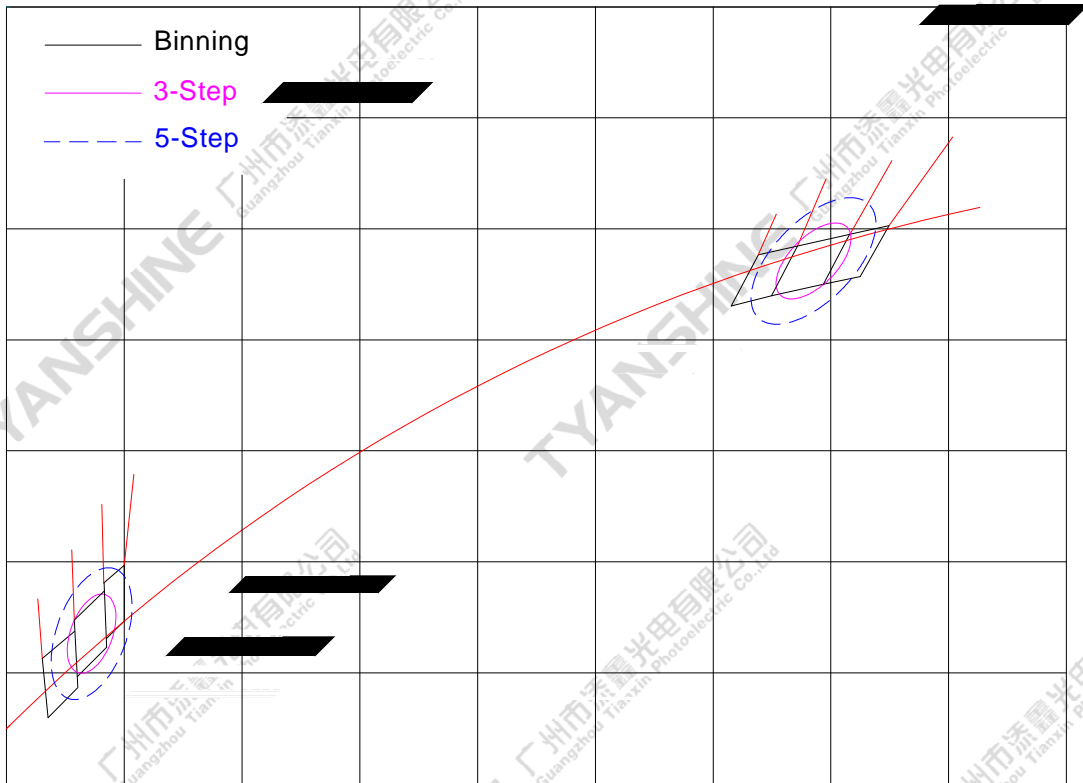

Reliability Test

Test Item	Test Condition
Continuous Operation Test	IF=200mA Ta=25 ×1000hrs
Low Temperature Storage Test	-30 × 1000 hours
High Temperature Storage Test	100 × 1000 hours
Moisture-proof Test	85 , 85 %RH for 500 hours
Thermal Shock Test	-30 × 30 minutes – 100 × 30 minutes, 100 cycle

