

CANEC24021252902

2024 10 09

1

12

Jany Zhong

CANEC24021252902

2024 10 09

2 12



CANEC24021252902

2024 10 09

3 12

| | | | MDL | A1 | A2 | A3 |
|--------------|------|-------|-----|----|----|----|
| (OctaBB) | - | mg/kg | 25 | ND | ND | ND |
| (NonaBB) | - | mg/kg | 25 | ND | ND | ND |
| (DecaBB) | - | mg/kg | 25 | ND | ND | ND |
| (PBDE) | 1000 | mg/kg | - | ND | ND | ND |
| (MonoBDE) | - | mg/kg | 25 | ND | ND | ND |
| (DiBDE) | - | mg/kg | 25 | ND | ND | ND |
| (TriBDE) | - | mg/kg | 25 | ND | ND | ND |
| (TetraBDE) | - | mg/kg | 25 | ND | ND | ND |
| (PentaBDE) | - | mg/kg | 25 | ND | ND | ND |
| (HexaBDE) | - | mg/kg | 25 | ND | ND | ND |
| (HeptaBDE) | - | mg/kg | 25 | ND | ND | ND |
| (OctaBDE) | - | mg/kg | 25 | ND | ND | ND |
| (NonaBDE) | - | mg/kg | 25 | ND | ND | ND |
| (DecaBDE) | - | mg/kg | 25 | ND | ND | ND |
| (2-) (DEHP) | 1000 | mg/kg | 50 | ND | ND | ND |
| (BBP) | 1000 | mg/kg | 50 | ND | ND | ND |
| (DBP) | 1000 | mg/kg | 50 | ND | ND | ND |
| (DIBP) | 1000 | mg/kg | 50 | ND | ND | ND |

| | | | MDL | A4 | A5 | A6 |
|-----------|------|---------|-----|----|----|----|
| (Pb) | 1000 | mg/kg | 2 | 4 | ND | 4 |
| (Hg) | 1000 | mg/kg | 2 | ND | ND | ND |
| (Cd) | 100 | mg/kg | 2 | ND | ND | ND |
| (Cr(VI)) | 1000 | mg/kg | 8 | ND | ND | ND |
| (PBB) | 1000 | mg/kg | - | ND | ND | ND |
| (MonoBB) | - | mg/kg | 25 | ND | ND | ND |
| (DiBB) | - | mg/kg | 25 | ND | ND | ND |
| (TriBB) | - | mg/kg | 25 | ND | ND | ND |
| (TetraBB) | - | mg/kg | 25 | ND | ND | ND |
| (PentaBB) | - | mg/kg | 25 | ND | ND | ND |
| (HexaBB) | - | mg/kg | 25 | ND | ND | ND |
| (HeptaBB) | - | mg/kg | 25 | ND | ND | ND |
| (OctaBB) | - | mg/kg | 25 | ND | ND | ND |
| (NonaBB) | - | mg/kg | 25 | ND | ND | ND |
| (DecaBB) | - | mg/kg | 25 | ND | ND | ND |
| (PBDE) | 1000 | mg/kg | - | ND | ND | ND |
| (MonoBDE) | - | mg/kg | 25 | ND | ND | ND |
| (DiBDE) | - | G -0.01 | | | | |



CANEC2402125

2024 10 09

4 12

| | | MDL | A4 | A5 | A6 |
|--------------|-------|-----|----|----|----|
| (OctaBDE) | mg/kg | 25 | ND | ND | ND |
| (NonaBDE) | mg/kg | 25 | ND | ND | ND |
| (DecaBDE) | mg/kg | 25 | ND | ND | ND |
| (2-) (DEHP) | mg/kg | 50 | ND | ND | ND |
| (BBP) | mg/kg | 50 | ND | ND | ND |
| (DBP) | mg/kg | 50 | ND | ND | ND |
| (DIBP) | mg/kg | 50 | ND | ND | ND |



CANEC24021252902

2024 10 09

5 12

(3) 2021 7 22

DEHP BBP DBP DIBP

ILAC-G8:09/2019

w=0

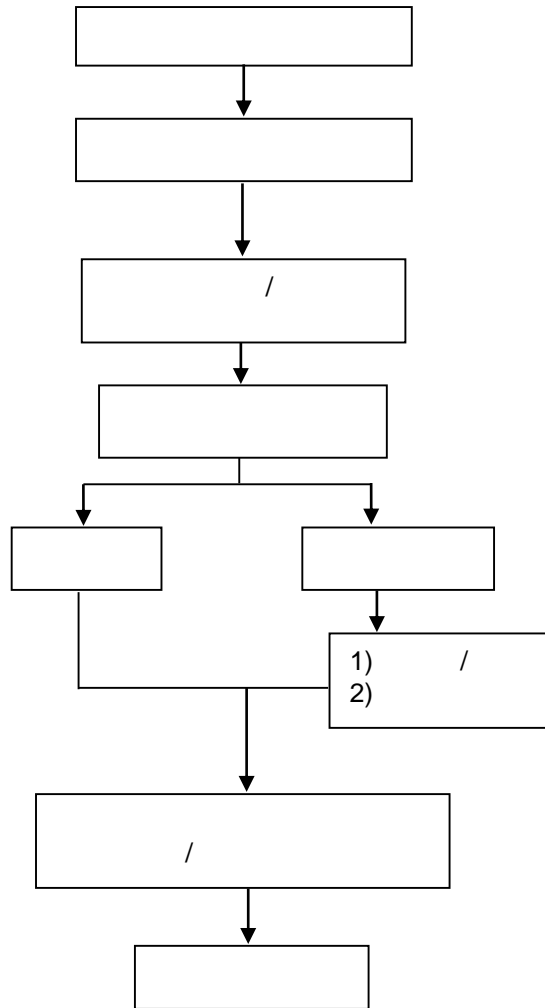

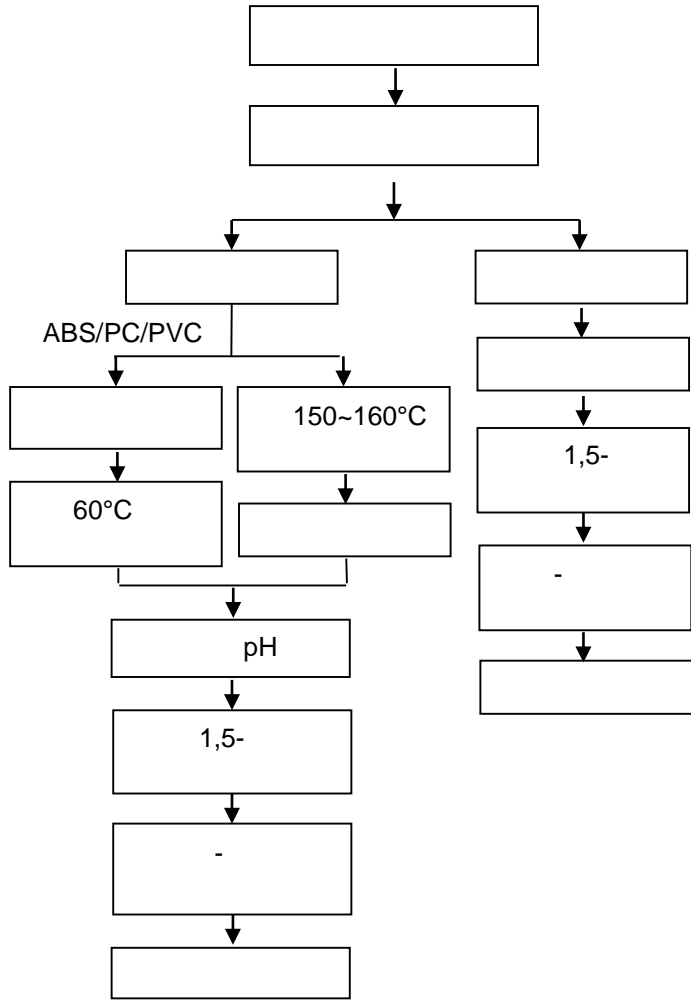



PBB/PBDE/Phthalates



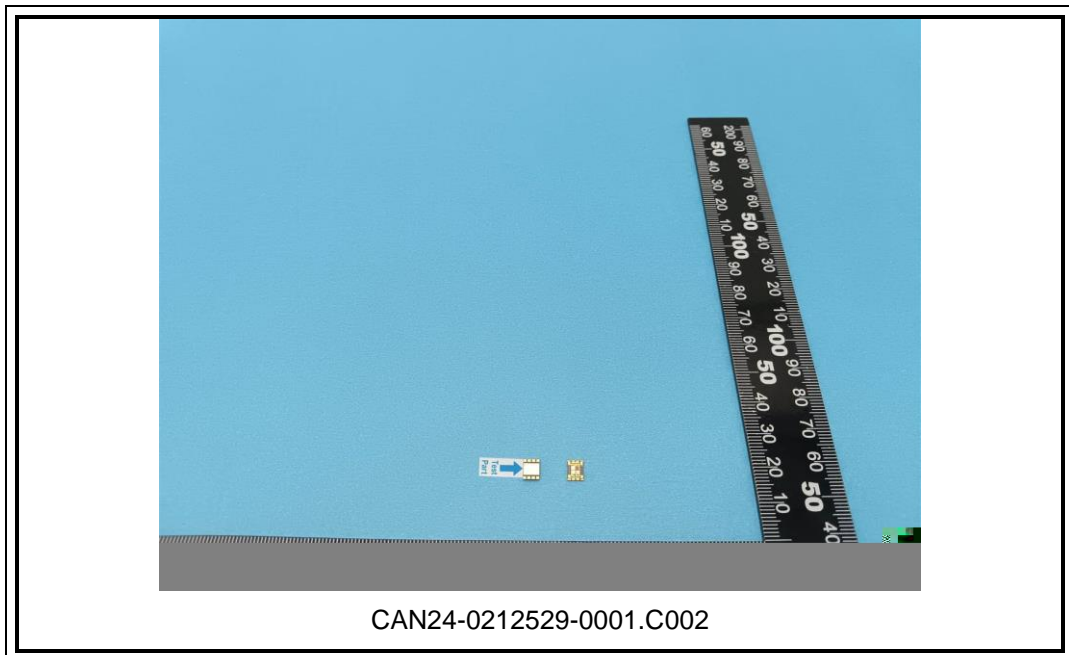
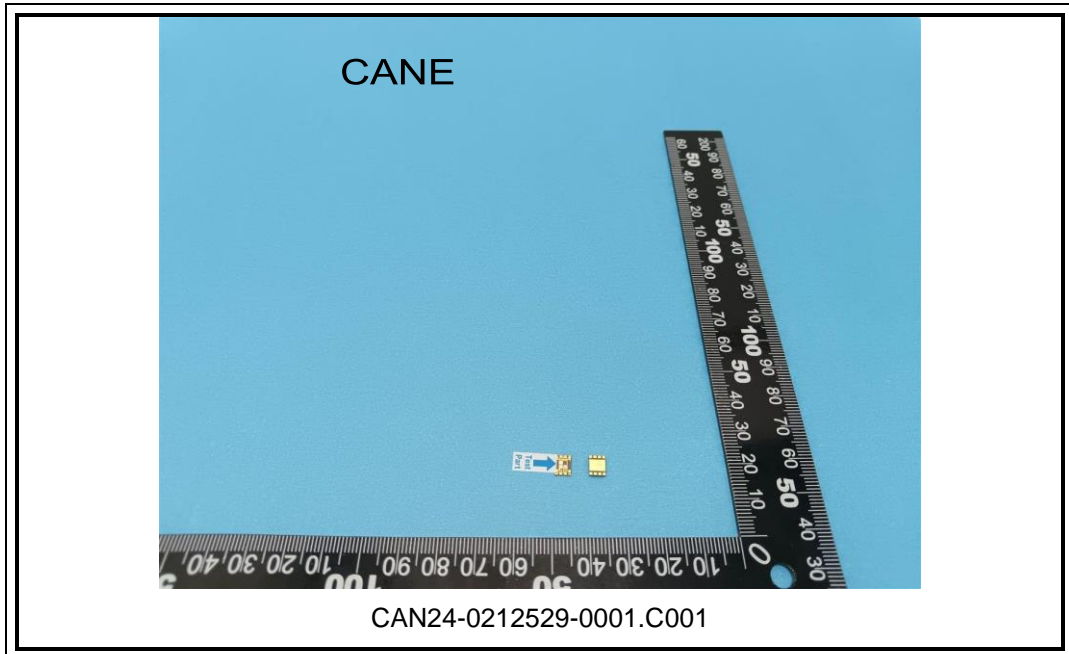

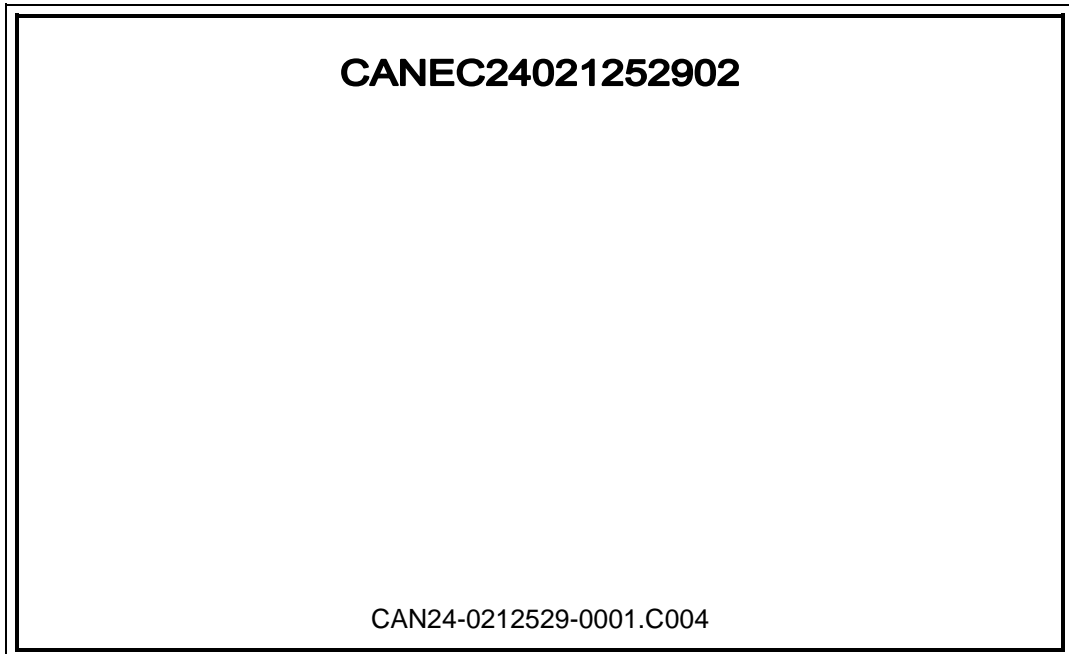
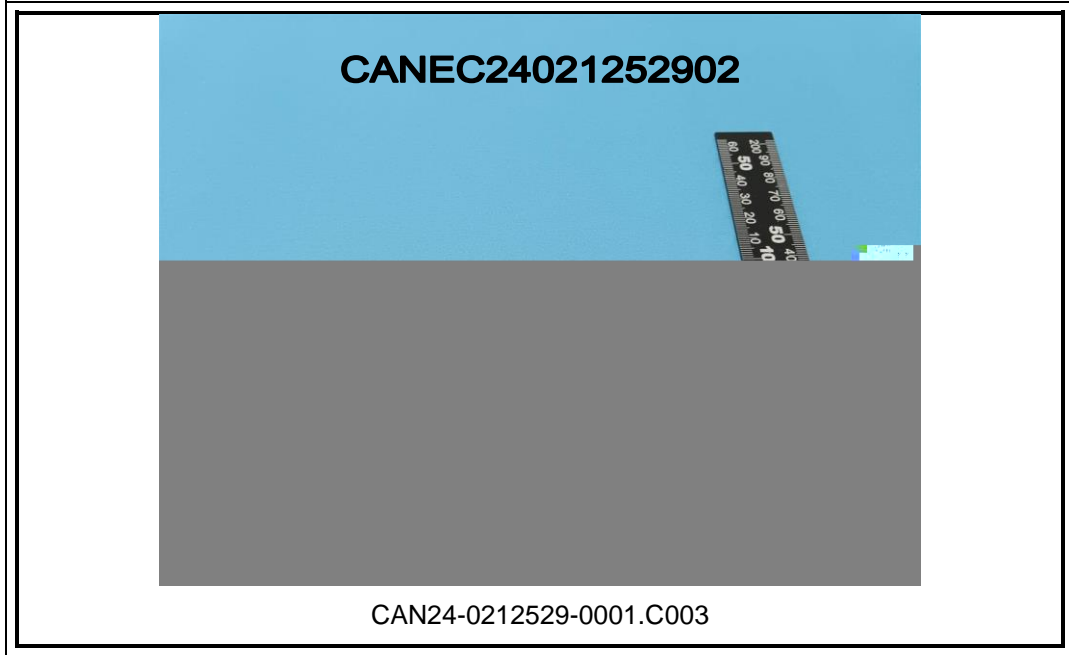

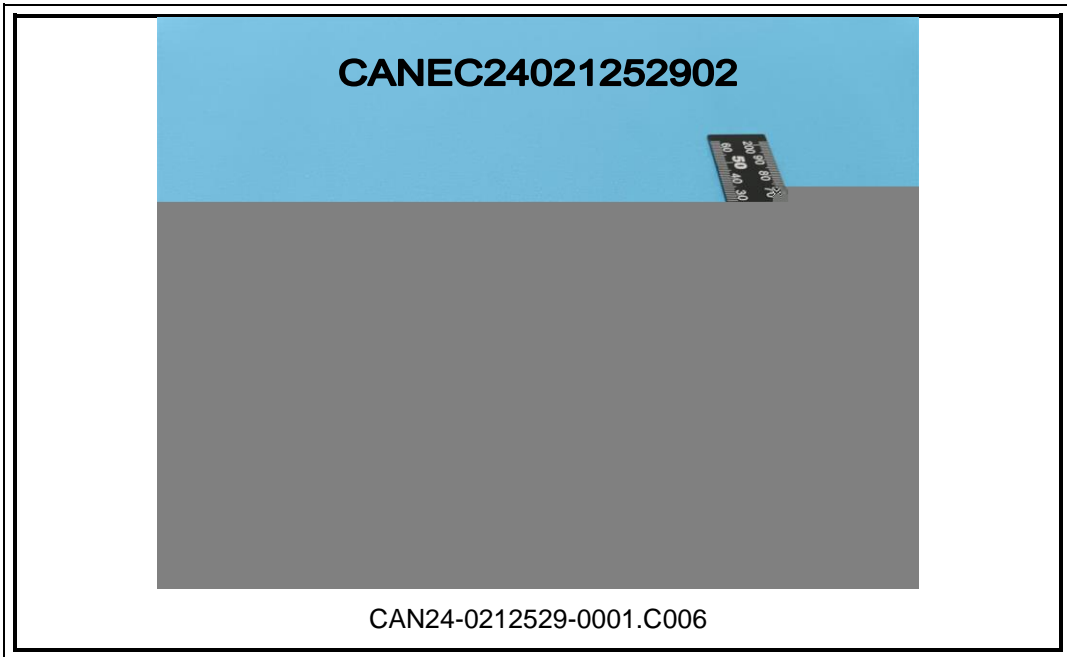
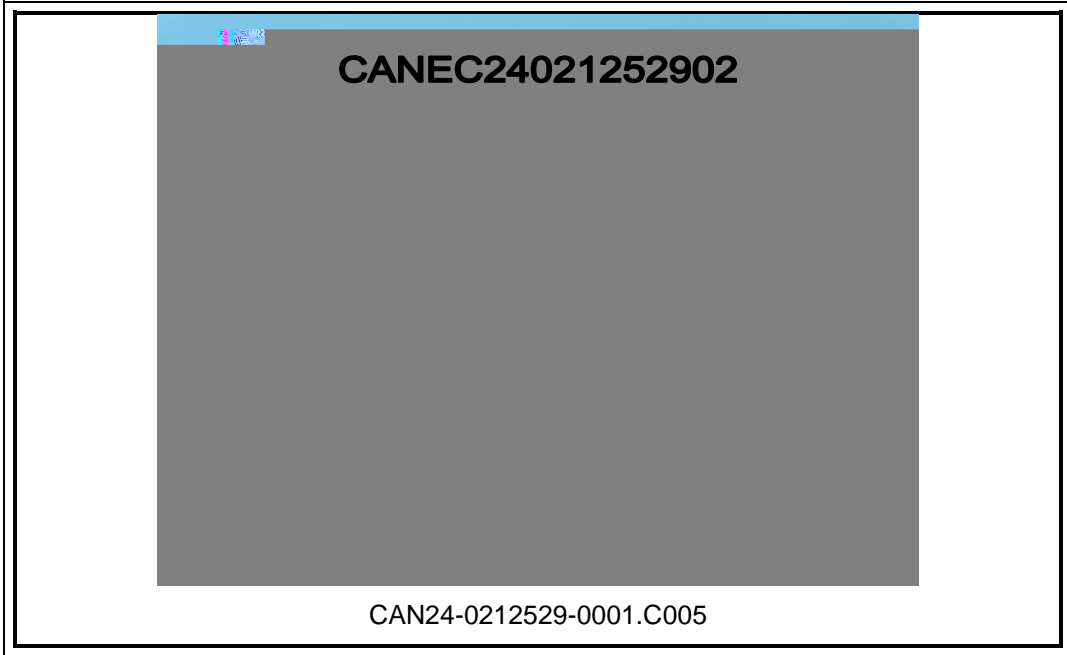

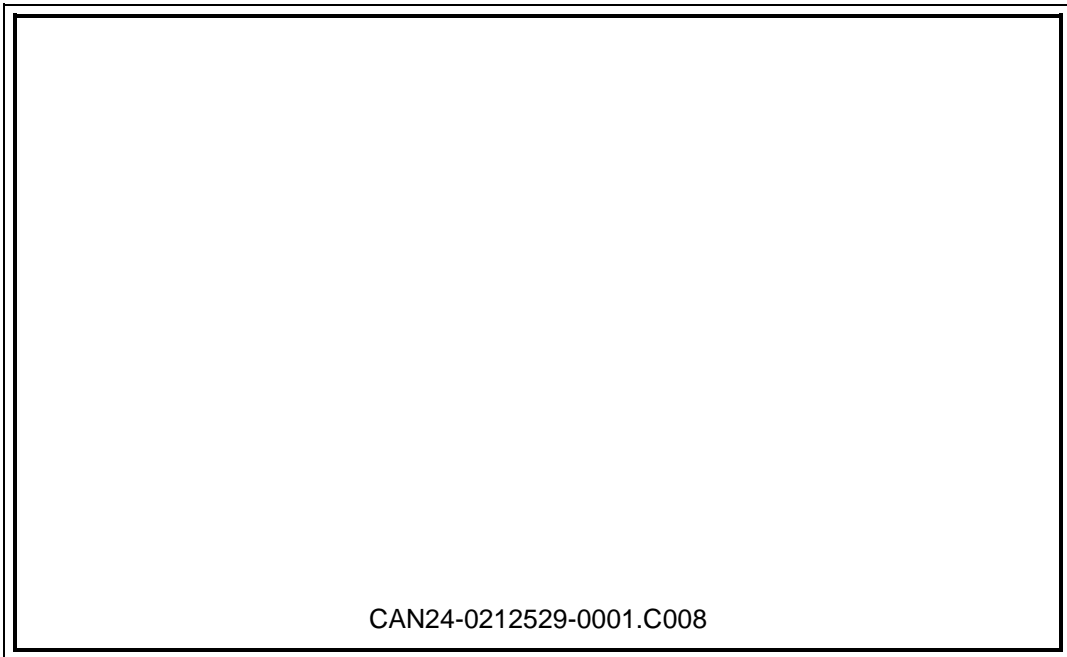
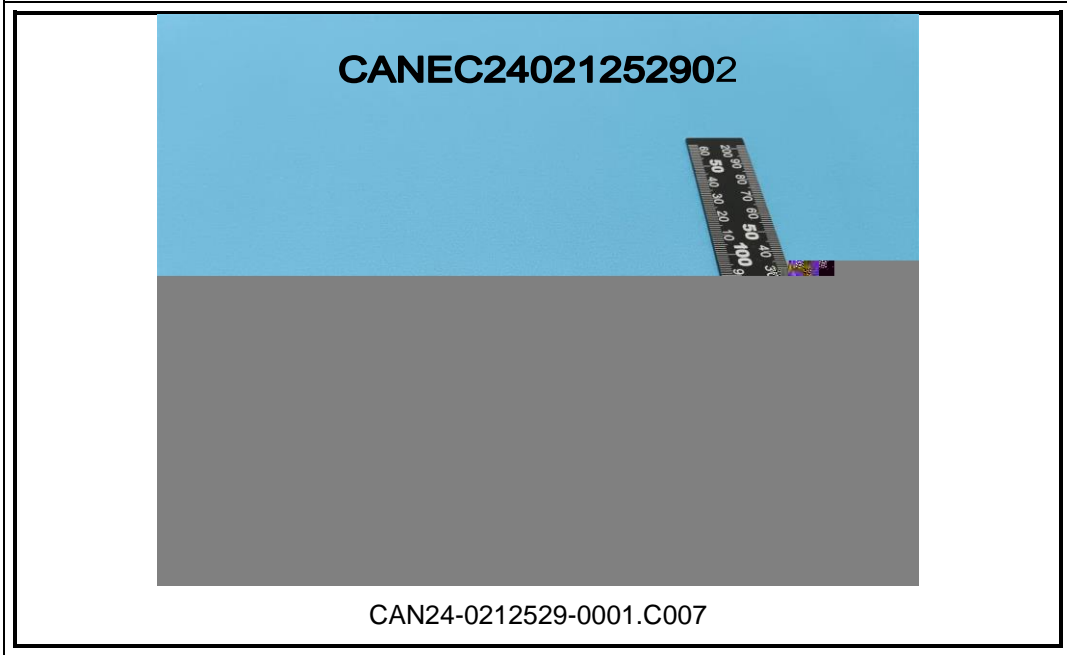

SGS
